

COBOTS

GRIPPING SOLUTIONS FOR COLLABORATIVE ROBOTS



Plug & Play kits with user-friendly Software
plug-in developed in collaboration with the
main cobot manufacturers



KIT COBOT GIMATIC

One Kit, unlimited solutions

Over the years, Gimatic has approached the world of Cobots, starting to establish important collaborations with big companies in the sector.

Gimatic began to create specific solutions for collaborative robots, which consist in Plug & Play Kits, complete with plug-in software. The range includes collaborative grippers and tool changers.



Main features:

1 The **Kit** is directly connected to the robot wrist. There are not cable along the robot arm.

2 Plug-in software dedicated and developed directly by Gimatic.

3 Simple and immediate **Plug & Play** installation.

Why the Gimatic Cobot Kits?

Gimatic kits make it easier the use of collaborative robots by having in a single product, the elements necessary to use the gripper or tool changer. All in a simple and intuitive way, according to the Gimatic philosophy.



- > Customized solutions for satisfying customer needs.
- > In-house development of mechatronic components.
- > All Cobot kits are developed to adapt to the different collaborative robots on the market.

Gimatic has developed Software Plug-ins for two major Cobot manufacturers: Techman Robot and Universal Robots. These plug-ins are developed entirely by the company, with the coordination of Techman Robot and Universal Robots.

The software allows to simplify the configuration and use of the gripper because the user can set some key settings such as the list of parts to be gripped, the type of grip and the coordinates of the gripping points, before use. This makes the Gimatic Kits even more intuitive and quick, guaranteeing the user a simple and safe use experience.

A kit for every need

Find out which Gimatic kits are the best for your needs and your Cobots.

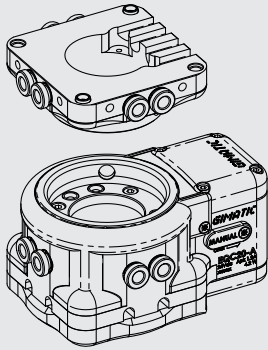

KIT-EQC20

 UNIVERSAL ROBOTS
 TECHMAN ROBOT

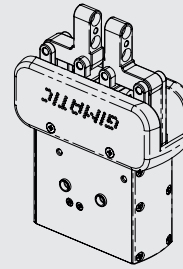

KIT-J

 UNIVERSAL ROBOTS
 TECHMAN ROBOT

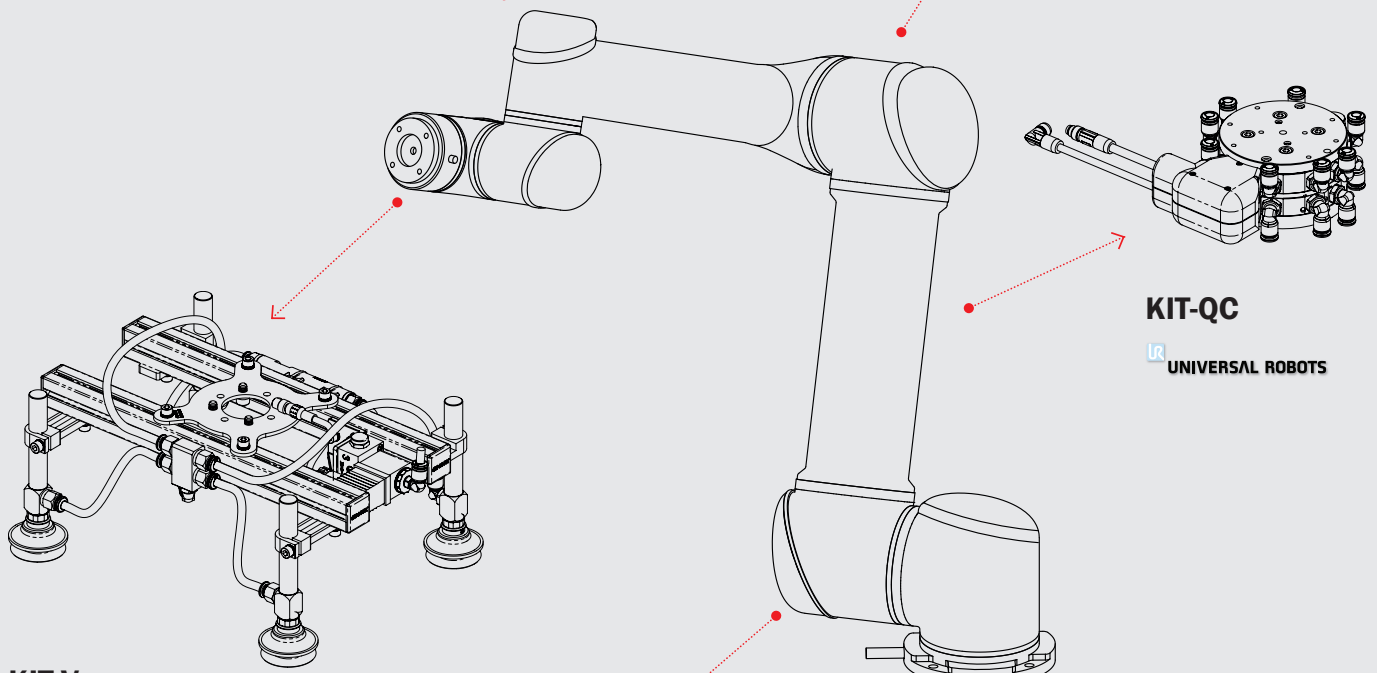

KIT-V

 UNIVERSAL ROBOTS
 TECHMAN ROBOT

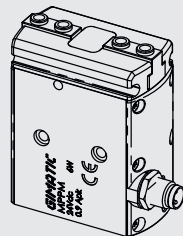

KIT-G

 UNIVERSAL ROBOTS

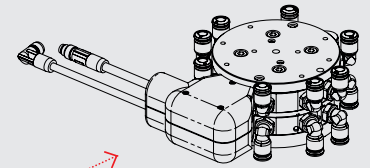

KIT-QC

 UNIVERSAL ROBOTS

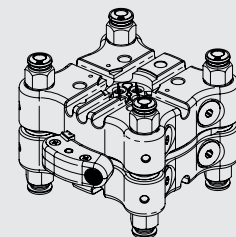

KIT-QC75

 UNIVERSAL ROBOTS
 TECHMAN ROBOT

KIT COBOT TECHMAN ROBOT



KIT-TM-J

- The Kit consists of the **MPRJ2553NP** parallelogram electric gripper with plastic cover and Capacitor Box.
- Like all Gimatic TM Kits, it can be installed on the whole Techman Robot series.

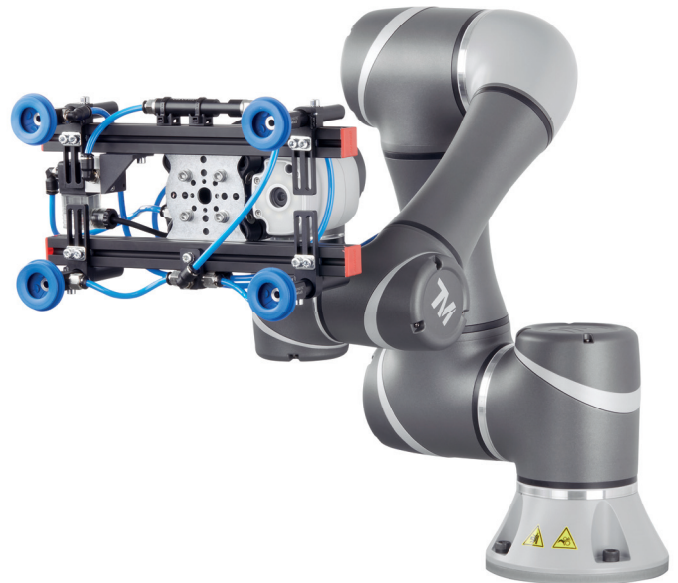

KIT-TM-V

- The EOAT system of this Kit allows to carry out Pick & Place operations by the integrated vacuum generator.
- Like all Kits, it is Plug & Play.



KIT-TM-EQC20

- The kit allows easy replacement of the EOAT.
- It includes all the components necessary to supply electrical and pneumatic energy to the tool.



KIT-TM-QC75

- Manual tool changer with pneumatic and electrical connections.
- By manually moving the lever, the user can connect or disconnect the two parts.



KIT COBOT UNIVERSAL ROBOTS



KIT-UR-G

- The Kit is composed by 2-jaws electric gripper **MPPM1606** with plastic cover and Capacitor Box.
- The Capacitor Box allows direct connection to the robot's wrist, providing at the gripper the needed energy.

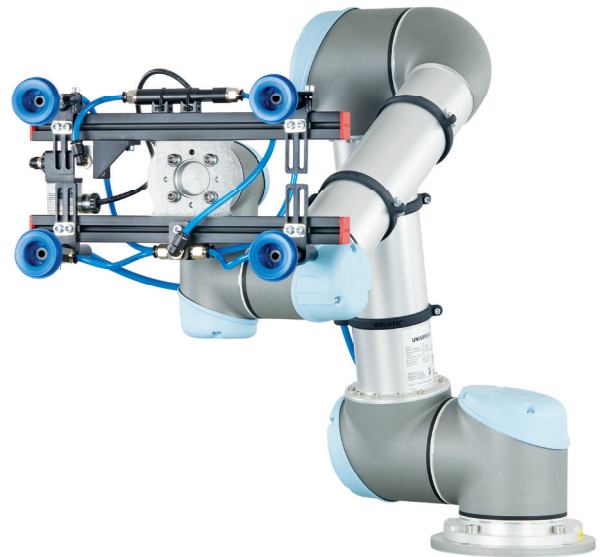

KIT-UR-V

- End of arm tool with vacuum system for Pick & Place operations.
- **EJ-LINE** vacuum generator that allows quick responses and high energy efficiency.

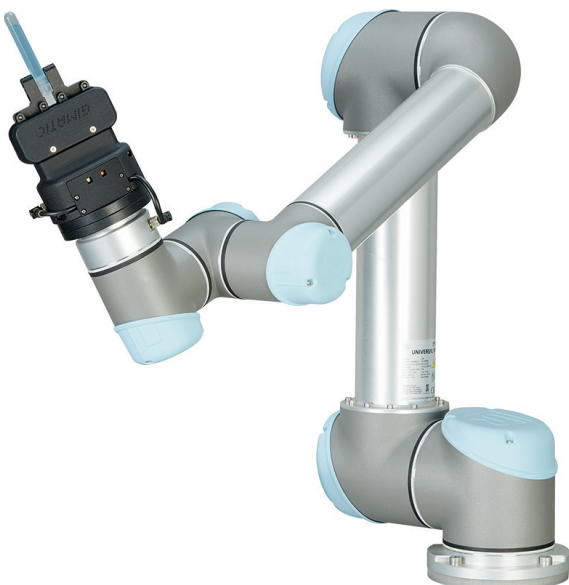

KIT-UR-J

- The Kit is composed by **MPRJ2553NP** parallelogram electric gripper with plastic cover and Capacitor Box.
- The gripper is perfect for making long strokes in short times since the force remains constant along the stroke.

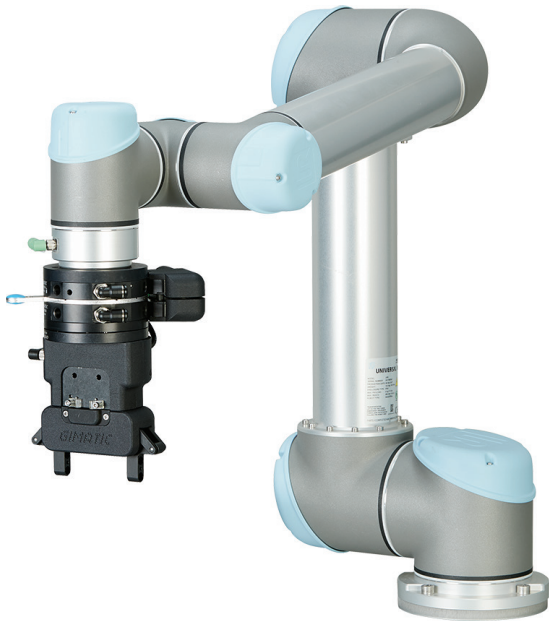

KIT-UR-QC

- Manual tool changer with pneumatic and electrical connections.
- By manually moving the lever, the user can connect or disconnect the two parts.



KIT-UR-EQC20 Coming soon

- The **EQC20** is an electric tool changer that allows a simple replacement of the EOAT on the robot.
- The Plug & Play solution makes installation simple, without the need for configuration.

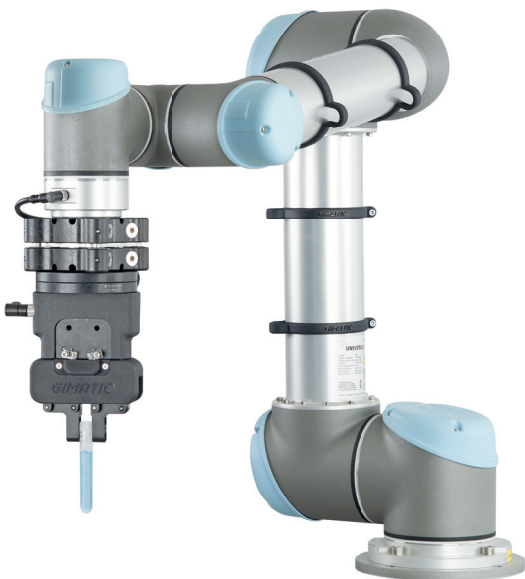

KIT-UR-QC75

- Manual tool changer with pneumatic and electrical connections.
- This Kit is compatible with other UR Gimatic Kits: UR-G, UR-J, UR-V.



Via Enzo Ferrari, 2/4
25030 Roncadelle (BS) ITALY

tel. +39 030 2584655
fax +39 030 2583886

info@gimatic.com
www.gimatic.com



Sales Network